

Specification Sheet

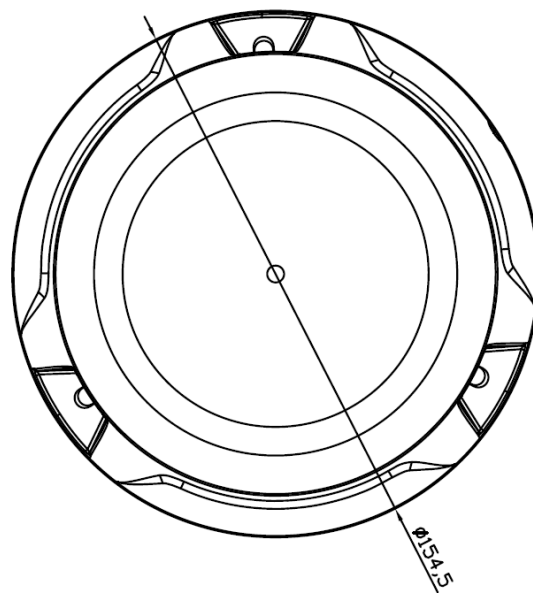

Technical Specifications:

Height	170 mm
Lens Colour	Amber
Output Colour	Amber
Lens Material	Makrolon 2607 Polycarbonate
Housing Material	Diecast Aluminium
Weight	330g
Input voltage	10-33V
LED's	6 x 5W
Current Draw	1A @ 12V
SAE	J845 Class1, W3-1
ECE R65	N/A, separate model
ECE R10	10R-06.22895
CISPR25	Class 3
ROHS	✓ - LCS210803145AR
REACH	✓ - LCS210803146AR
IP Rating	IP67
Operating Temperature	-30° — +60°
Vibration tests	IEC 60068-2-64
Mechanical Shock Test	ISO 16750-3:2007 4.2.2

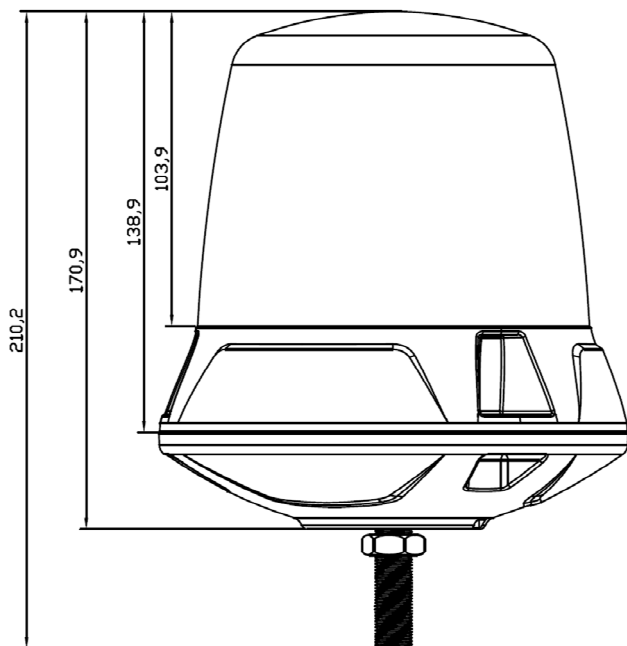
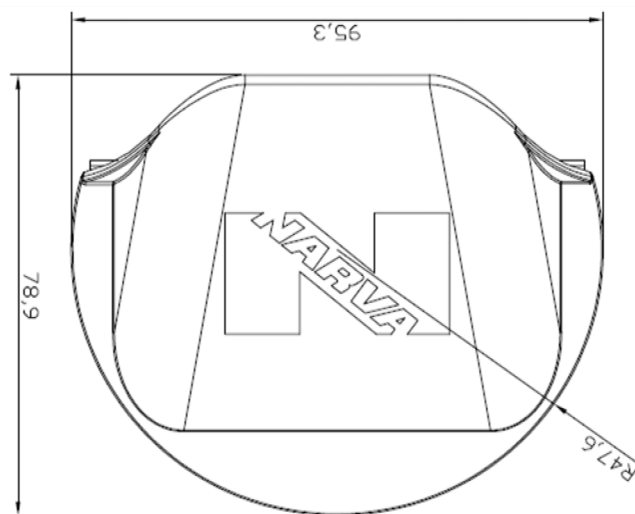

Internal reflector

Wiring Diagram:

Red—Positive DC

Black—Ground/negative

Distributed by Brown and Watson International

1500 Ferntree Gully Road, Knoxfield, 3180

P.) 1800 422 422